

RackView Widescreen 17"

Sliding KVM Drawer - 1920 x 1080

Installation and Operation Manual



ROSE.COM

10707 Stancliff Road
Houston, Texas 77099



Phone: (281) 933-7673
techsupport@rose.com

LIMITED WARRANTY

Rose Electronics® warrants the RackView Widescreen 17" KVM Drawer to be in good working order for one year from the date of purchase from Rose Electronics or an authorized dealer. Should this product fail to be in good working order at any time during this one-year warranty period, Rose Electronics will, at its option, repair or replace the Unit as set forth below. Repair parts and replacement units will be either reconditioned or new. All replaced parts become the property of Rose Electronics. This limited warranty does not include service to repair damage to the Unit resulting from accident, disaster, abuse, or unauthorized modification of the Unit, including static discharge and power surges.

Limited Warranty service may be obtained by delivering this unit during the one-year warranty period to Rose Electronics or an authorized repair center providing a proof of purchase date. If this Unit is delivered by mail, you agree to insure the Unit or assume the risk of loss or damage in transit, to prepay shipping charges to the warranty service location, and to use the original shipping container or its equivalent. You must call for a return authorization number first. Under no circumstances will a unit be accepted without a return authorization number. Contact an authorized repair center or Rose Electronics for further information.

ALL EXPRESS AND IMPLIED WARRANTIES FOR THIS PRODUCT INCLUDING THE WARRANTIES OF MERCHANTABILITY AND FITNESS FOR A PARTICULAR PURPOSE, ARE LIMITED IN DURATION TO A PERIOD OF ONE YEAR FROM THE DATE OF PURCHASE, AND NO WARRANTIES, WHETHER EXPRESS OR IMPLIED, WILL APPLY AFTER THIS PERIOD. SOME STATES DO NOT ALLOW LIMITATIONS ON HOW LONG AN IMPLIED WARRANTY LASTS, SO THE ABOVE LIMITATION MAY NOT APPLY TO YOU.

IF THIS PRODUCT IS NOT IN GOOD WORKING ORDER AS WARRANTIED ABOVE, YOUR SOLE REMEDY SHALL BE REPLACEMENT OR REPAIR AS PROVIDED ABOVE. IN NO EVENT WILL ROSE ELECTRONICS BE LIABLE TO YOU FOR ANY DAMAGES INCLUDING ANY LOST PROFITS, LOST SAVINGS OR OTHER INCIDENTAL OR CONSEQUENTIAL DAMAGES ARISING OUT OF THE USE OF OR THE INABILITY TO USE SUCH PRODUCT, EVEN IF ROSE ELECTRONICS OR AN AUTHORIZED DEALER HAS BEEN ADVISED OF THE POSSIBILITY OF SUCH DAMAGES, OR FOR ANY CLAIM BY ANY OTHER PARTY.

SOME STATES DO NOT ALLOW THE EXCLUSION OR LIMITATION OF INCIDENTAL OR CONSEQUENTIAL DAMAGES FOR CONSUMER PRODUCTS, SO THE ABOVE MAY NOT APPLY TO YOU. THIS WARRANTY GIVES YOU SPECIFIC LEGAL RIGHTS AND YOU MAY ALSO HAVE OTHER RIGHTS WHICH MAY VARY FROM STATE TO STATE.

DECLARATIONS OF CONFORMITY

This is to certify that, when installed and used according to the instructions in this manual, the units listed and described here are shielded against the generation of radio interferences in accordance with the application of Council Directives 2014/30/EU and 2014/30/EU, as well as these standards:

- EN 55022: 2010/AC:2011 (Class B)
- EN 55024:2010 + A1:2015

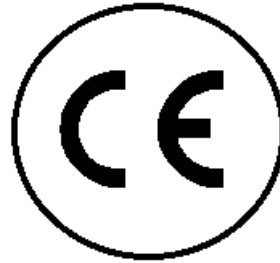

This equipment has been found to comply with the limits for a Class A digital device, pursuant to Part 15 of the FCC Rules. These limits are designed to provide reasonable protection against harmful interference when the equipment is operated in a commercial environment. This equipment generates, uses, and can radiate radio frequency energy and, if not installed and used in accordance with the instruction manual, may cause harmful interference to radio communications. Operation of this equipment in a residential area is likely to cause harmful interference in which case the user will be required to correct the interference at their own expense.

This equipment fully complies with the requirements of European Union Regulation (EC) 1907/2006 concerning the Registration, Evaluation, Authorization and Restriction of Chemicals (REACH):

These devices comply with Directive 2011/65/EU of the European Parliament and of the council of 8 June 2011 on the restriction of the use of certain hazardous substances in electrical and electronic equipment (RoHS 2, RoHS II). The device labels carry a respective marking.

TABLE OF CONTENTS

Contents

Disclaimer	1
System Introduction	1
Features	1
Package Contents	2
RackView Options	2
RackView Model	3
RackView Layout	3
RackView Rear Panel Connector Layout	3
Installation Procedure	4
Installation of the RackView Widescreen 17-inch	4
Operation of the RackView Widescreen 17-inch	5
Cabling RackView to an External Device	6
Connection to a PS2 or USB Server	6
Connection to an External KVM Switch	6
RackView Cables	7
Troubleshooting	7
RackView Operation	8
Power-On Procedure	8
Video Input Select Button	8
OSD Selection	8
OSD Operation	9
Safety	10
Maintenance and Repair	11
Technical Support	11

Figures

Figure 1. RackView product layout - key features	3
Figure 2. RackView rear panel connector layout	3
Figure 3. RackView installation procedure	4
Figure 4. RackView console drawer operation	5
Figure 5. RackView cable connectivity	6
Figure 6. RackView device interface cables	7
Figure 7. OSD menu selection	8
Figure 8. RackView OSD configuration and settings	9
Figure 9. RackView chassis dimensions	14
Figure 10. RackView integrated KVM switch models	15
Figure 11. RackView with HDMI video option	16
Figure 12. HDMI cable connection	16
Figure 13. RackView with 3G/HD/SD-SDI video option	16
Figure 14. Schematic showing the back panel with the touchscreen option (USB-A) installed	18
Figure 15. RackView touchscreen setup procedure	18
Figure 16. RackView with a DC power connector fitted	19

TABLE OF CONTENTS

Tables

Table 1. RackView product and packaging dimensions	14
Table 2. RackView product and packaging dimensions (including a KVM switch).....	14
Table 3. Video resolution related to LCD specification	15
Table 4. DVI-D and VGA video formats.....	17
Table 5. 3G/HD/SD-SDI video formats	17
Table 6. RackView DC power options	19

Appendices

Appendix A — Specifications	12
Appendix B — Part Numbers	13
Appendix C — RackView Dimensions	14
Appendix D — RackView with Integrated KVM Switch	15
Appendix E — RackView Video Options	16
Appendix F — RackView Touchscreen	18
Appendix G — RackView DC Power Options	19

INTRODUCTION

Disclaimer

While every precaution has been taken in the preparation of this manual, the manufacturer assumes no responsibility for errors or omissions. Neither does the manufacturer assume any liability for damages resulting from the use of the information contained herein. The manufacturer reserves the right to change the specifications, functions, circuitry of the product, and manual content at any time without notice.

The manufacturer cannot accept liability for damages due to misuse of the product or other circumstances outside the manufacturer's control. The manufacturer will not be responsible for any loss, damage, or injury arising directly or indirectly from the use of this product (See limited warranty).

System Introduction

Thank you for choosing the Rose Electronics RackView Widescreen 17" Console Drawer. This product is the result of Rose Electronics' commitment to providing state-of-the-art solutions for today's demanding workplace. The RackView is the ideal product for managing one or more PC's/Servers in a confined rack space.

The RackView is manufactured using a steel chassis to withstand constant mechanical movement in the rack. The 17" LCD monitor supports 1920×1080 video resolution, with both VGA and DVI video interfaces available. The keyboard tray includes a 2-button touchpad mouse, and either a PS2 or USB connector is available for keyboard and mouse operation, via an external interface cable.

There are several options available with the RackView, including the integration of a VGA/USB or DVI/USB KVM switch for PC/Server management, providing an all-in-one console management solution.

The instructions in this manual assume a general knowledge of computer installation procedures, familiarity with cabling requirements, and some understanding video display device operation.

Features

- 1U model with 17.3" Widescreen TFT/LCD monitor resolution up to 1920 x 1080, VGA or DVI
- Front panel controls provide access to the OSD for set-up and quick adjustments of color, brightness, contrast, position, and shape of the display
- USB or PS/2 touchpad/keyboard interface
- Full size 104 keyboard with a separate numeric keypad and a 2-button touchpad mouse
- Supports Windows, Linux, Unix, Sun, MAC OS
- Panel protected by tempered glass
- Active EDID monitor function
- Quick and easy "one-man" rack mounting installation, the RackView drawer can be mounted at any height in a standard 19" rack
- Fold and tilt the LCD Monitor for optimum viewing position
- 18 International keyboard versions available
- Mounting rails included
- Optional DVI/USB or VGA/USB KVM Switch

Package Contents

The RackView package contents consist of the following:

- 1 x RackView sliding KVM drawer
- 1 x Mounting bracket (sliding rails) set
- 1 x Set of screws/washers for assembly
- 1 x Combo interface cable (depending on the model selected)
- 1 x Power supply unit
- 1 x Power cable
- 1 x Manual

The above package content is only for the single console model. The contents can vary with options such as a KVM switch, HDMI and 3G/SDI video and DC power.

Additional cables are usually ordered separately. If the package contents are not correct, contact Rose Electronics or your reseller so the problem can be quickly resolved.

RackView Options

- Integrated KVM switch, DVI USB Audio (12 port) or VGA USB (8 or 16 port)
- HDMI (replaces the DVI interface)
- 3G/HD/SD-SDI video
- Resistive Touchscreen
- Front USB 2.0 port for device access, available with the KVM-Hub switch option only
- Trackball mouse
- DC power, 12, 24, 48, 125, 250V

Before Installation

It is very important to mount the equipment in a suitable cabinet or on a stable surface.

Make sure the mounting location has good ventilation, is out of direct sunlight, and away from sources of excessive dust, dirt, heat, water, moisture, and vibration.

MODELS

RackView Model

The RackView is available as described below.

RackView Layout

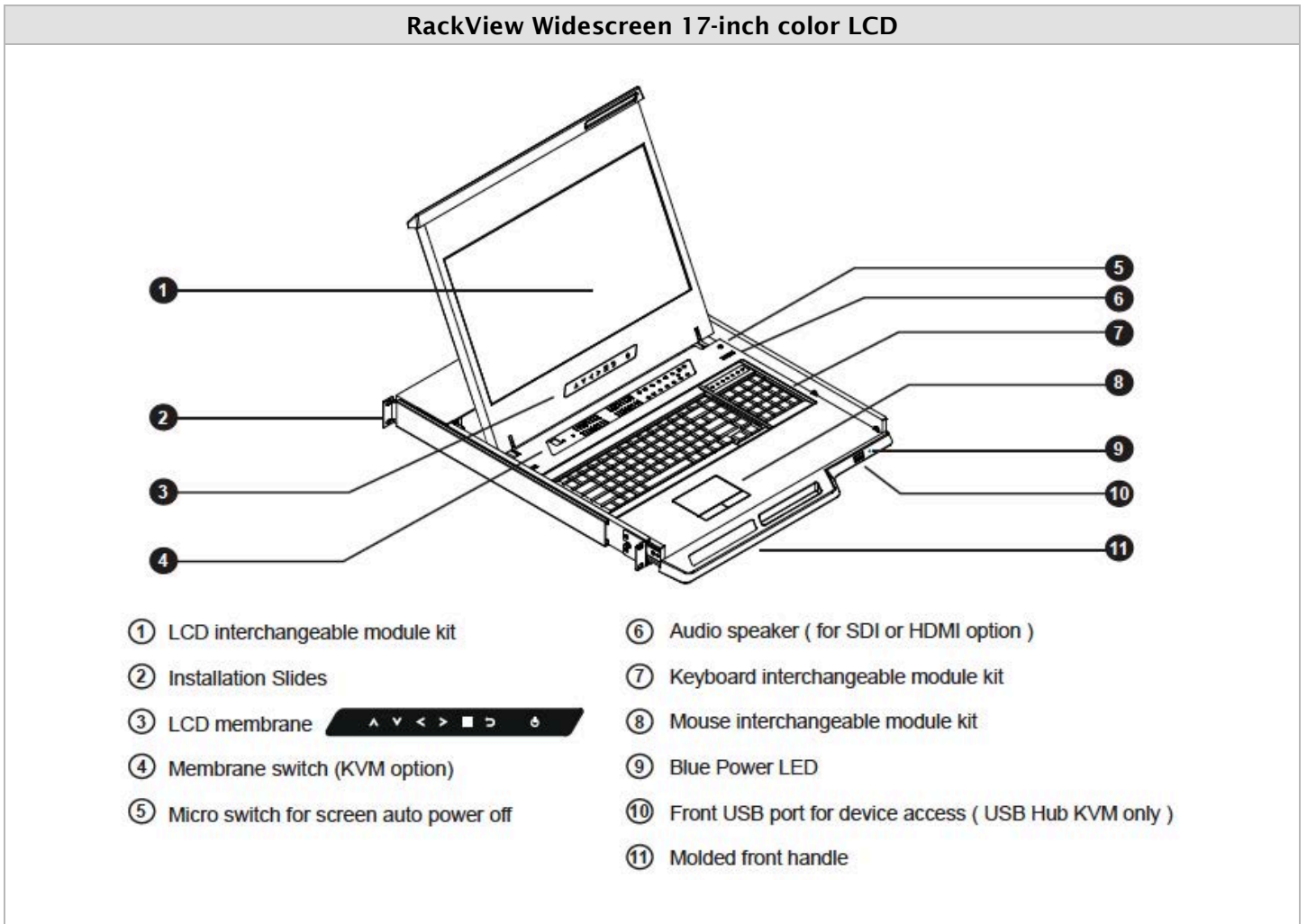

Figure 1. RackView product layout - key features

RackView Rear Panel Connector Layout

The RackView rear panel includes an HD15(KVM) and DVI-D connector as standard. The HD15(KVM) connector supports VGA video, and also the keyboard/mouse interface.

This diagram shows the approximate positioning of the DVI-D and KVM connectors on the rear panel.

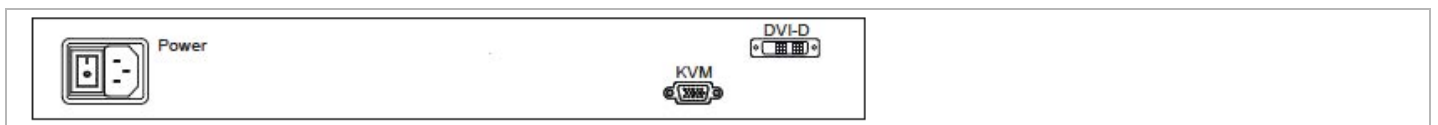

Figure 2. RackView rear panel connector layout

INSTALLATION

Installation Procedure

Installation of the RackView Widescreen 17-inch

	<p>Step 1 Insert the Left and Right rear-mounting slides into the RackView Console Drawer</p>
	<p>Step 2 Measure the depth of the front and rear rack rails Align each rear-mounting slide to a suitable length (depth)</p>
	<p>Step 3 Complete the Installation Fix the RackView Console Drawer into the Rack A set of mounting accessories is provided</p>

Figure 3. RackView installation procedure

Operation of the RackView Widescreen 17-inch

	<p>Step 1 Hold the handle and slide out the RackView drawer</p>
	<p>Step 2 Flip up the LCD to a suitable viewing angle</p>
	<p>Step 3 Operate the RackView Console Drawer</p>

Figure 4. RackView console drawer operation

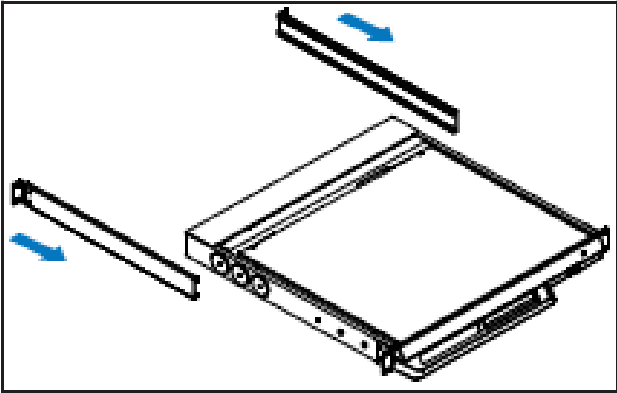
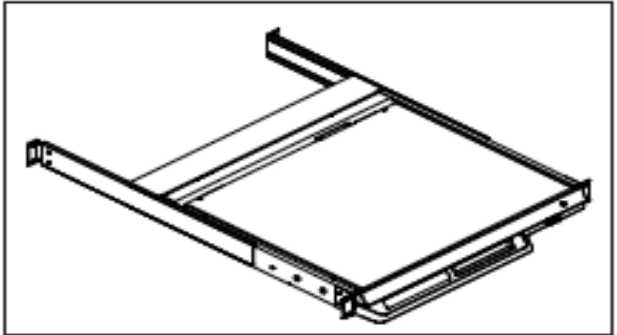
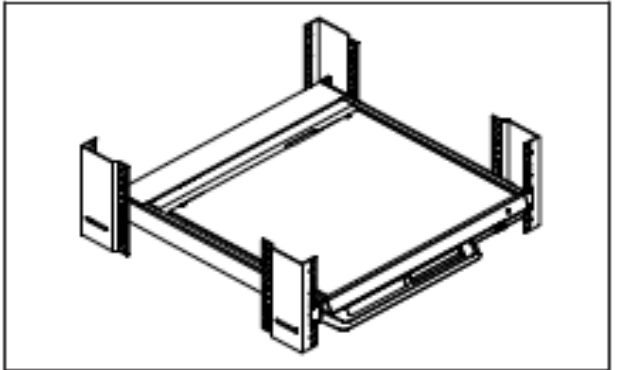
Cabling RackView to an External Device

Connection to a PS2 or USB Server

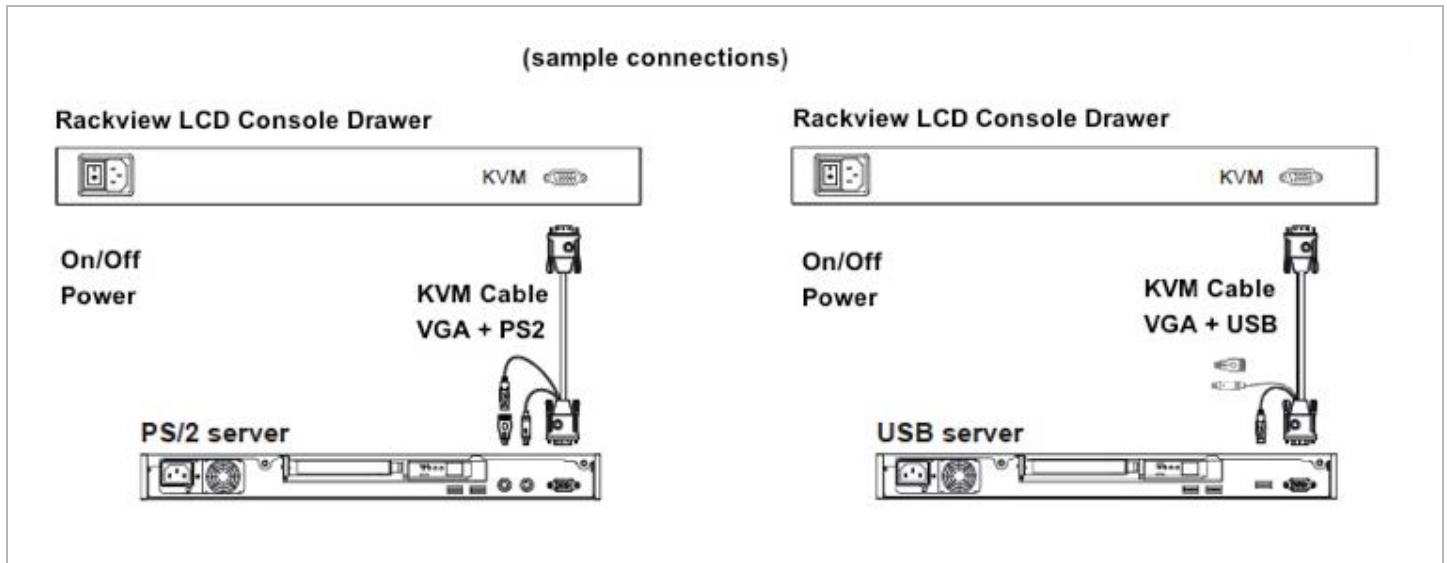

Connection to an External KVM Switch

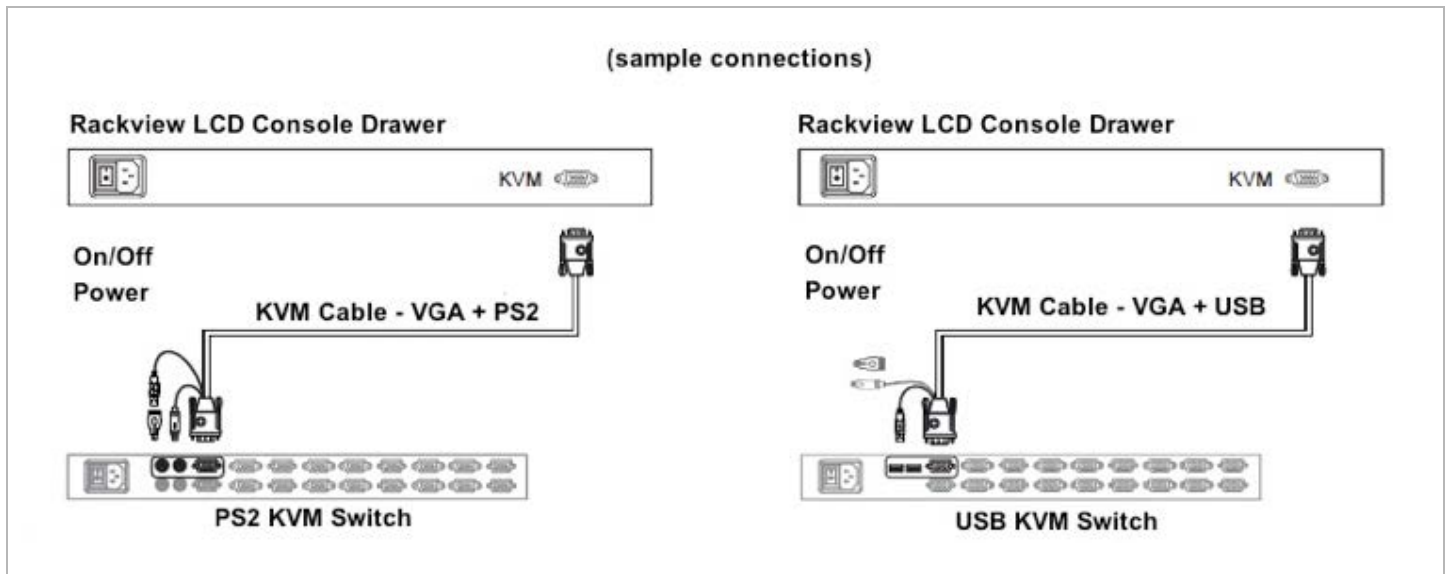

Figure 5. RackView cable connectivity

Note: Cabling options include either a VGA/USB, a VGA/PS2, or a DVI/USB cable.

Note: Please check cable details with your supplier.

Caution: The RackView KVM drawer is hot-pluggable, but components of connected devices, such as the servers and KVM switch, may not be hot-pluggable. Plugging and unplugging cables while servers and KVM switch are powered-on may cause irreversible damage to the servers, KVM and LCD console drawer. Before attempting to connect anything to the RackView, we suggest turning off the power to all devices. Apply power to connected devices only after the RackView has been powered-on. Rose Electronics is not responsible for any product damage or warranty claims caused in this way.

OPERATION

RackView Cables

There are 3 different combo connection cables available for RackView. The user should select one of these cables at time of order placement. These cables are used to connect the RackView to either a PC or an external KVM switch

Add either /K1, /K2 or /K3 onto the RackView part number



Figure 6. RackView device interface cables

The RackView can support 4 different video interfaces, VGA, DVI-D, and the optional HDMI and 3G-SDI. HDMI and SDI cables are available from Rose Electronics.

Troubleshooting

If the RackView KVM Drawer fails to synchronize correctly with the attached product (PC, Switch, Extender), and the monitor displays a distorted video pattern, press the screen power reset button once on the RackView keyboard tray to re-synchronize the video signal

OPERATION

RackView Operation

Power-On Procedure

- Power on the RackView (see power switch on back panel)
- Power on the KVM Switch or other connected product
- Power on the CPU

Video Input Select Button







- The RackView remembers the last valid video input selection, so if the CPU input has changed, the user needs to re-select the video input.
- Locate the “Video Input Select” button on the OSD display control panel
- Push the Video Input Select button to toggle between VGA and DVI Input
- Select the appropriate Video Input format (VGA or DVI)





OSD Selection

OSD Selection Panel



Membrane Switch	Function
	Turn the monitor on or off
	Display the OSD menu Act as an Enter key to select screen setting options
  	Scroll through menu options and adjust the displayed control
	Exit the OSD screen Go back to the previous on-screen sub-menu or main menu

Remark : All LED touch buttons in **WHITE** light.
The LED of Power  touch button will flash continuously when there is no signal input.

- ① All the LED touch buttons will automatically turn off after 10 minutes of idle status (except the Power ).
- ② Light up all membrane buttons, please press any button for 1 - 2 seconds (except the Power ).



OSD Configuration Page





-  **Image:**
for the brightness, contrast, color temp, red, green, and blue
-  **Geometry:**
for the auto adjust, H position, V position, phase and clock
-  **Video:**
for the colour, tint, sharpness, noise reduction, DCCI and TV Setup
-  **Audio:**
for volume, bass, treble, balance, AVL and mute
-  **Misc:**
for the language, OSD position, graphic mode, ratio, reset and timer

Figure 7. OSD menu selection

OSD Operation

OSD Configuration and Settings	
	<p>Picture</p> <p>Picture mode: Standard / Vivid / Soft / User mode to choose</p> <p>Brightness: Adjust background black level of the screen image</p> <p>Contrast: Adjust the difference between the image background (black level) and the foreground (white level)</p> <p>Hue: Adjust the screen hue value</p> <p>Saturation: Adjust the saturation of the image color</p> <p>Picture size: Adjust the image size</p> <p>Color temp: Standard / Cool / Warm / User to choose</p> <p>Noise reduce: Reduce the noise of the image</p> <p>Sharpness: Adjust the image from weak to sharp</p>
	<p>PC</p> <p>Auto adjust: Automatically adjust sizes, centers and fine tunes the video signal to eliminate waviness and distortion.</p> <p>Clock: Adjust the clock value</p> <p>Phase: Adjust the phase value</p> <p>H. Position: Align the screen image left or right</p> <p>V. Position: Align the screen image up or down</p>
	<p>Audio</p> <p>Audio mode: Movie / Voice / Normal / Music mode to choose</p> <p>Volume: Adjust the volume of sound</p> <p>Bass: Set the value of bass sound</p> <p>Treble: Set the value of treble sound</p> <p>Balance: Set the balance value of treble and bass sound</p> <p>Analog TV audio: Set the value of analog TV audio sound</p> <p>Mute: Turn off the surrounding sound</p>
	<p>Misc.</p> <p>Language: Select the language in which the OSD menu is displayed - English</p> <p>Sleep timer: Set the off time</p> <p>PIP mode: Adjust picture in picture setting</p> <p>PIP position: Enter into PIP position</p> <p>PIP source: Enter into the Sub source and sound source</p> <p>System reset: Return the adjustment back to factory setting</p> <p>Information: Select for Help</p>

Figure 8. RackView OSD configuration and settings

PRODUCT SAFETY

Safety

The RackView KVM Drawer, like all electronic equipment, should be used with care. To protect yourself from possible injury and to minimize the risk of damage to the Unit, read and follow these safety instructions.

- Follow all instructions and warnings marked on this Unit.
- Except where explained in this manual, do not attempt to service this Unit yourself.
- Do not use this Unit near water.
- Assure that the placement of this Unit is on a stable surface.
- Provide proper ventilation and air circulation.
- Keep connection cables clear of obstructions that might cause damage to them.
- Use only power cords, power adapter and connection cables designed for this Unit.
- Keep objects that might damage this Unit and liquids that may spill, clear from this Unit. Liquids and foreign objects might come in contact with voltage points that could create a risk of fire or electrical shock.
- Do not use liquid or aerosol cleaners to clean this Unit. Always unplug this Unit from the power source before cleaning.

Remove power from the unit and refer servicing to a qualified service center if any of the following conditions occur:

- The connection cables are damaged or frayed.
- The Unit has been exposed to any liquids.
- The Unit does not operate normally when all operating instructions have been followed.
- The Unit has been dropped or the case has been damaged.
- The Unit exhibits a distinct change in performance, indicating a need for service.

SERVICE AND MAINTENANCE

Maintenance and Repair

This Unit does not contain any internal user-serviceable parts. In the event a Unit needs repair or maintenance, you must first obtain a Return Authorization (RA) number from Rose Electronics or an authorized repair center. This Return Authorization number must appear on the outside of the shipping container.

See Limited Warranty for more information.

When returning a Unit, it should be double-packed in the original container or equivalent, insured and shipped to:

Rose Electronics

Attn: RA _____

10707 Stancliff Road

Houston, Texas 77099 USA

Technical Support

If you are experiencing problems, or need assistance installing your product, consult the appropriate section of this manual. If, however, you require additional information or assistance, please contact the Rose Electronics Technical Support Department at:

Phone: (281) 933-7673

E-mail: TechSupport@rose.com

Web: www.rose.com

Technical Support hours are from: 8:00 am to 6:00 pm CST (USA), Monday through Friday.

Please report any malfunctions in the operation of this Unit or any discrepancies in this manual to the Rose Electronics Technical Support Department.

APPENDICES

Appendix A – Specifications

Chassis Details	
Display Monitor	17.3" Widescreen TFT Color LCD, 1U height
Drawer Dimensions	17.4 x 18.1x 1.73 inch (441.6 x 460 x 44 mm)
Weight	23.8 lb (10.8Kg)
Display Size	17.3 inch
Mounting Rail Distance	18.5 – 27.6 inch (470-700mm)
Video Specification	
Maximum Resolution	1920 x 1080 @60Hz
Brightness and Backlight Type	400 cd/m ² , LED
Color Support	16.7M, 8-bit
Contrast Ratio (typical.)	600:1
Viewing Angle (H/V)	80/80/60/80 (L/R/U/D)
Dot Pitch	0.1989mm
Display Area	381.88 H x 214.81 V mm
Response Time	40ms
Surface Treatment	Anti-glare, hard coating
Surface Hardness	3H
DVI Signal	DVI-D, TMDS single-link
HDMI Signal	HDMI 1.3, CEA-861-D
VGA Signal	Analog 0.7Vp-p
Sync. Type (VGA)	Separate, Composite and Sync-On-Green
Plug & Play DDC (DVI and VGA)	VESA EDID 1.3
Connectors and Controls	
Console Ports (standard model) (one cable included)	1 x DVI-D 1 x KVM (for VGA video, keyboard and mouse signals)
Power	1 x IEC power connector
Display power switch	1 x Display power-off switch on the front panel
USB2.0	1 x USB2.0 port on the front panel with the USB-Hub switch option
Power	
Power Input	Auto-sensing 100 to 240VAC, 50 / 60Hz
Power Consumption	Screen ON = 25W or less, Power Saving Mode = 4W or less
Environmental, Approvals and Support	
Operating Temp	0° to 55°C Degree
Storage Temp	-20° to 60 °C Degree
Operating Humidity	Operating: 20~90%, non-condensing
Shock	10G acceleration (11ms duration)
Vibration	5~500Hz 1G RMS random vibration
Regulation/Approvals	cUL, FCC, CE, RoHS2, REACH
Compatibility	Multi-platform - Mix PCs, SUNs, IBMs, HPs and DELLs.
LCD Panel MTBF	50,000 hours

Appendix B – Part Numbers

Part Number	Description
RV1-CAKVT17/DWS/HD/Kn	RackView Widescreen 17", 1920 x 1080 Ultra HD, KVM Rack Drawer, Touchpad Mouse, (for Kn, see cables below)
RackView Interface Cable: (only 1 cable is included – select with order). For above model only	
/K1:	CAB-CMBVMUAC005: HD15 to HD15 + 1 x USB-A. (VGA +USB)
/K2:	CAB-CMBVM66C005: HD15 to HD15 + 2 x PS2. (VGA +PS2)
/K3:	CAB-CMBDVUAC005: DVI-D + HD15(M) to DVI-I + 1 x USB-A
RackView + KVM Switch	
RV1-CAKVT17/DWS/HD/KVM12TDVI-K1	RackView Widescreen 17" with 12-port DVI/USB KVM Switch + 6 x DVI/USB 6ft cables
RV1-CAKVT17/DWS/HD/KVM108CMB-K1	RackView Widescreen 17" with 8-port VGA/USB KVM Switch + 8 x VGA/USB 6ft cables
RV1-CAKVT17/DWS/HD/KVM116CMB-K1	RackView Widescreen 17" with 16-port VGA/USB KVM Switch + 16 x VGA/USB 6ft cables
RV1-CAKVT17/DWS/HD/KVM108CMH-K1	RackView Widescreen 17" with 8-port VGA/USB KVM Switch + 8 x VGA/USB 6ft cables, with a 2-port USB2.0 Hub
RV1-CAKVT17/DWS/HD/KVM116CMH-K1	RackView Widescreen 17" with 16-port VGA/USB KVM Switch + 16 x VGA/USB 6ft cables, with a 2-port USB2.0 Hub
Additional CPU cables for KVM Switch	
CAB-CMBVMUAC006	CPU Cable, 6ft (2.0m) cable, Combo HD15 to VGA/USB
CAB-CMBVMUAC010	CPU Cable, 10ft (3.0m) cable, Combo HD15 to VGA/USB
CAB-CMBVMUAC015	CPU Cable, 15ft (4.5m) cable, Combo HD15 to VGA/USB
CAB-CMBDVUAC006	CPU Cable, 6ft (2.0m), DVI-D + Audio + USB-A to DVI-D+USB-B, (for DVI Switch)
CAB-CMBDVUAC015	CPU Cable, 15ft (4.5m), DVI-D + Audio + USB-A to DVI-D+USB-B, (for DVI Switch)
RackView Options	
/HM	HDMI video with audio
/SD	3G/HD/SD-SDI video
/KM	Trackball 2-button mouse option
/nnnDC	12/24/48/125/250V DC power
/nn	Keyboard Language Option: /UK, /FR, /IT, /DN, /BE, /NO, /DE, /ES, /PO, /SI, /SD, /DA, /JP, /TW. Add /nn to part

Appendix C – RackView Dimensions

RackView Dimensions: Package Size and Weight

Model	Product Dimension (W × D × H) approx	Packing Dimension (W × D × H) approx	Net Weight	Gross Weight
RV1-CAKVT17/DWS/HD/Kn	441.6 × 460 × 44 mm 17.4 × 18.1 × 1.73 inch	590 × 808 × 140 mm 23.2 × 31.8 × 5.5 inch	23.8lb 10.8Kg	34.8lb 15.8Kg

Table 1. RackView product and packaging dimensions

The above package content is only for the single RackView KVM Drawer. The package size and weight varies with options such as KVM switch, KVM combo cables, HDMI, SD, and DC power, as below. The rack depth for the 17" model: changes to 17.4 x 20.9 x 1.73 inch (441.6 x 530 x 44mm)

Package Size and Weight with Internal KVM Switch

Model-with KVM Switch	Product Dimension (W × D × H) approx	Packing Dimension (W × D × H) approx	Net Weight	Gross Weight
RV1-CAKVT17/DWS/HD/Kn with internal KVM Switch	441.6 × 580 × 44 mm 17.4 × 22.8 × 1.73 inch	590 × 808 × 140 mm 23.2 × 31.8 × 5.5 inch	25.5lb 11.6Kg	38.5lb 17.5Kg

Table 2. RackView product and packaging dimensions (including a KVM switch)

RackView Chassis Dimensions

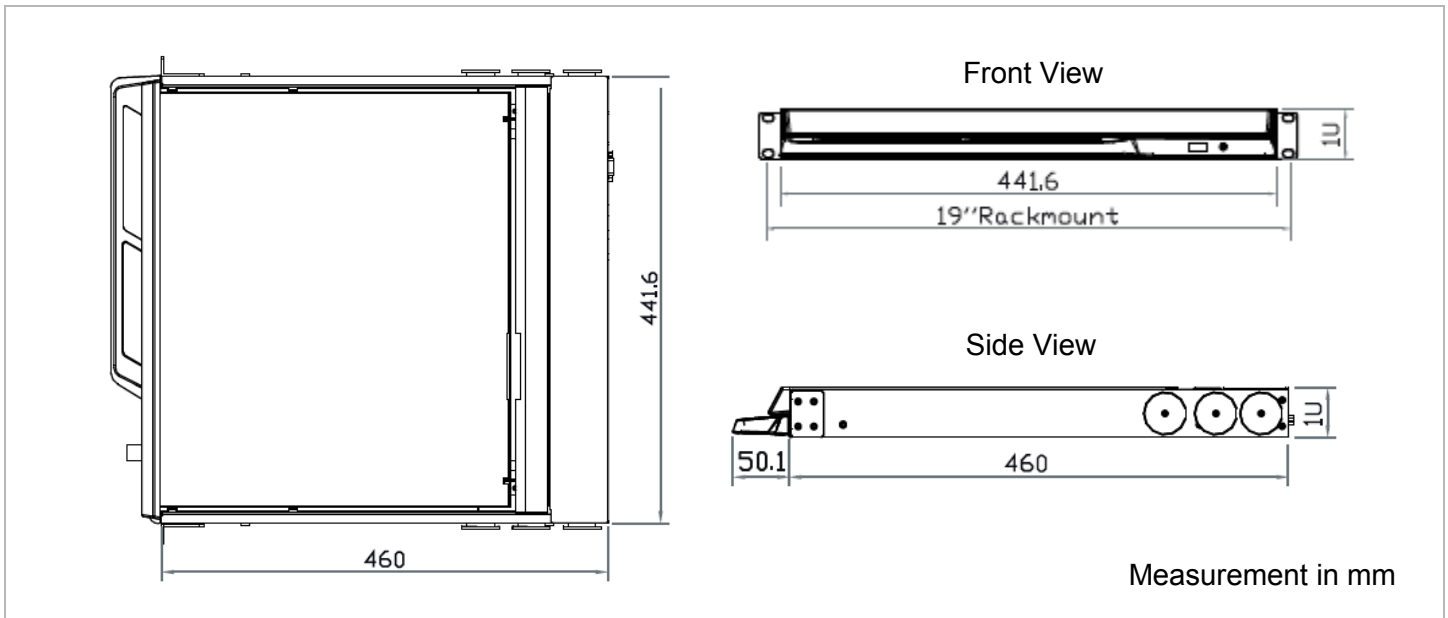

Figure 9. RackView chassis dimensions

Appendix D – RackView with Integrated KVM Switch

RackView Option with Integrated KVM Switch

The RackView KVM Drawer can be supplied with an integrated KVM switch mounted at the rear of the RackView unit, in a compact 1U package

The available switch options are;

- KVM-108CMB An 8-port single-user, VGA/USB switch with cascade port
- KVM-116CMB A 16-port single-user, VGA/USB switch with cascade port
- KVM-108CMH An 8-port single-user, VGA/USB switch with USB2.0 hub support
- KVM-116CMH A 16-port single-user, VGA/USB switch with USB2.0 hub support
- KVM-12DVI A 12-port single-user DVI/USB switch

When ordered as a complete kit (RackView + KVM Switch), the RackView and the Switch are connected internally. All that is required is to connect the CPU combo cables (VGA/USB or DVI/USB) from the rear panel of the switch to the host PC/Servers.

The RackView can then be used to select and operate the attached PC's/Servers.

Power consumption with KVM integration (Screen ON = 59W, Power Saving = 29W)

KVM Switch Models – Rear Panel View

	KVM-108CMB 8-port KVM Switch VGA/USB + Cascade Port
	KVM-116CMB 16-port KVM Switch VGA/USB + Cascade Port
	KVM-108CMH 8-port KVM Switch VGA/USB + USB2.0 2-port Hub
	KVM-116CMH 16-port KVM Switch VGA/USB + USB2.0 2-port Hub
	KVM-12TDVI 12-port KVM Switch DVI/USB

Figure 10 RackView integrated KVM switch models

Maximum Video Resolutions Supported with an Integrated KVM Switch	
Video resolution Supported	16:10 Maximum 1920 x 1200 16:9 Maximum 1920 x 1080 4:3 Maximum 1600 x 1200

Table 3. Video resolution related to LCD specification

Appendix E – RackView Video Options

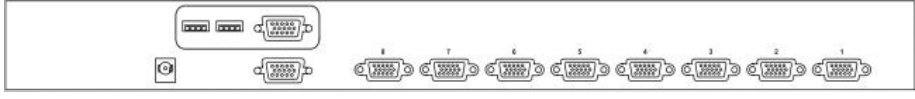
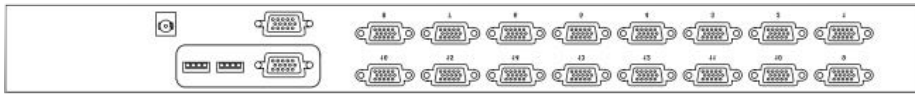
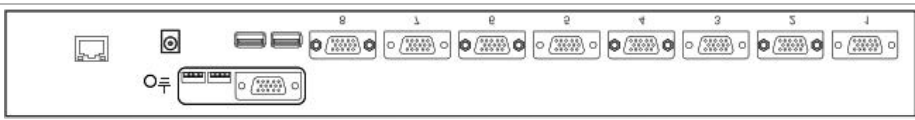
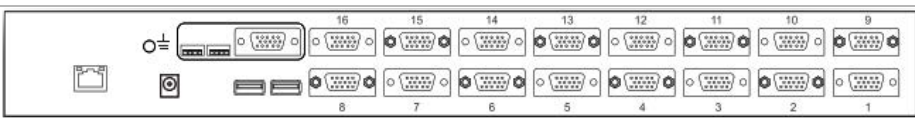
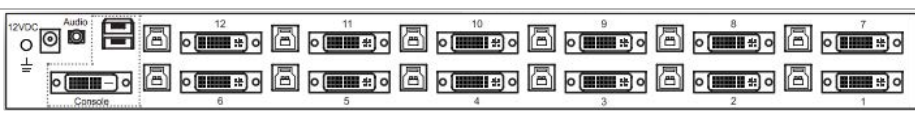
RackView Video Option with HDMI Video Interface

The RackView KVM Drawer can be ordered with optional HDMI interface in place of the DVI video interface. The diagram below shows the approximate positioning of these video connectors on the back panel. This option includes a factory fitted audio speaker on the keyboard tray.

The HDMI option will increase the standard RackView chassis depth from 18.1 inches to 20.86 inches (460mm to 530mm)

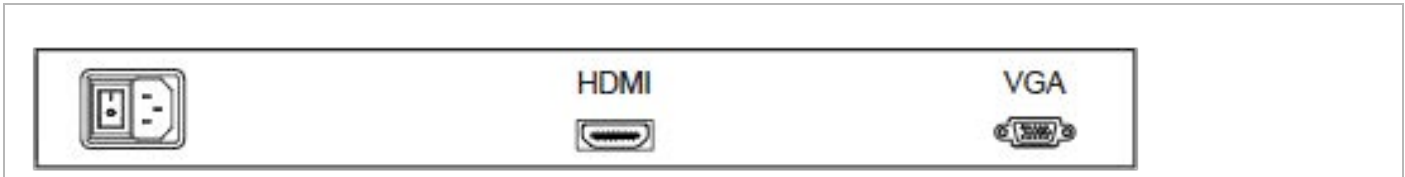

Figure 11. RackView with HDMI video option

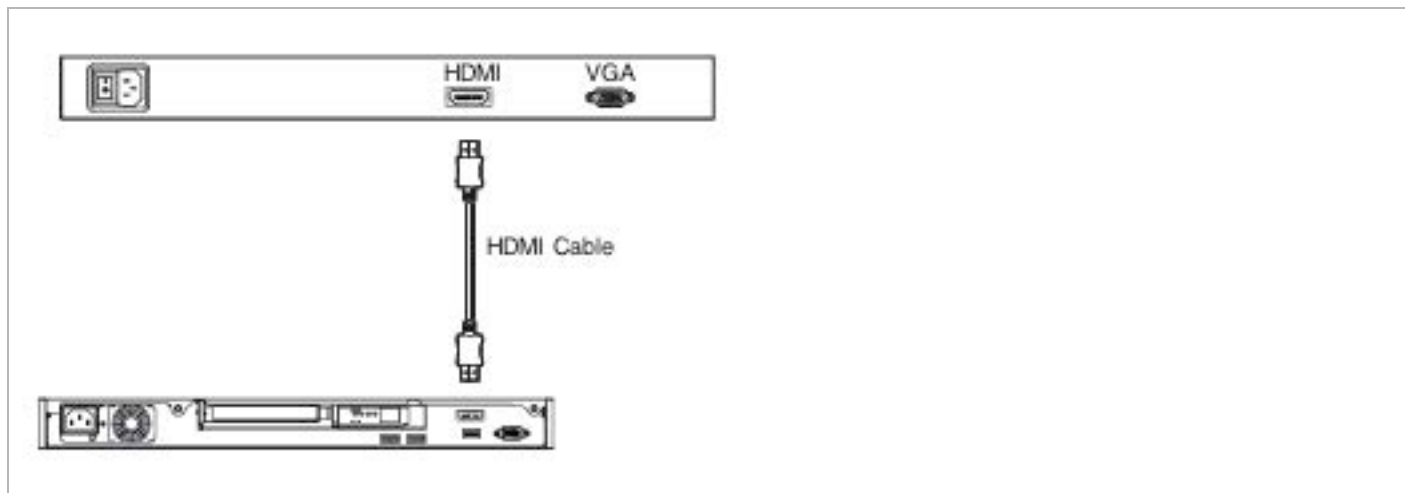

Figure 12. HDMI cable connection

RackView Video Option with 3G/HD/SD-SDI Video Interface

The RackView 3G/HD/SD-SDI video option is an ideal solution for the broadcast grade video and Widescreen CCTV market. The optional SDI input module can support up to 1080p@60Hz and comes with the full range of HDMI, DVI-D, VGA, S-Video, BNC, and audio inputs. This option includes a factory fitted audio speaker on the keyboard tray.

The 3G/HD/SD-SDI option will increase the standard RackView chassis depth from 18.9 inches to 20.86 inches (460mm to 530mm)

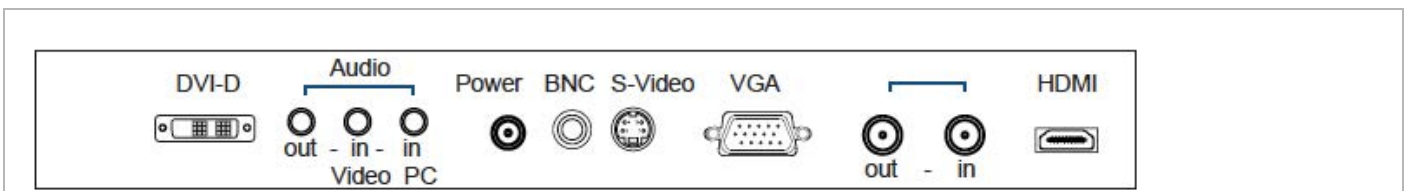

Figure 13. RackView with 3G/HD/SD-SDI video option

Video Formats (DVI-D and VGA)

DVI-D / VGA Input	PC Signal	Resolution/Refresh Rate
		1920 x 1080 x 60Hz
		1360 x 768 x 60Hz
		1280 x 1024 x 60Hz / 75Hz
		1280 x 960 x 60Hz
		1280 x 768 x 60Hz / 75Hz
		1152 x 864 x 75Hz
		1024 x 768 x 60Hz / 70Hz / 75Hz
		848 x 480 x 60Hz
		800 x 600 x 60Hz / 72Hz / 75Hz
		720 x 400 x 70Hz
		640 x 480 x 60Hz / 72Hz / 75Hz
		640 x 400 x 70Hz
HDMI Input	PC Signal	Same as VGA
	Video Signal	1080p, 60Hz
		720p, 50Hz / 60Hz
		480p, 60Hz
		576p, 50Hz
	Audio Signal	2-channel Linear PCM (32 / 44.1/48 KHz)
	Speaker	Dual stereo speaker, 2x2W

Table 4. DVI-D and VGA video formats

Video Formats (3G/HD/SD-SDI)

Description	Video Signal	Resolution/Refresh Rate/Signal
Input	3G-SDI In	BNC x 1 / 0.8Vp-p (75 ohm)
	3G-SDI Out	BNC x 1 / Active through, equalized & relocked
Standard Compliance	Video	SMPTE 425M / 274M / 296M / 125M ITU-R BT.656
	Audio	SMPTE 299M / 272M-C
Compatible Video Format	3G-SDI	1080p@60 / 50Hz, 4:2:2 1080p@30 / 25 / 24Hz, 4:4:4 1080i@60 / 50Hz, 4:4:4 720p@60 / 50Hz, 4:4:4
	HD-SDI	1080p@30 / 25 / 24Hz, 4:2:2 1080i@60 / 50Hz, 4:2:2 720p@60 / 50Hz, 4:2:2
	SG-SDI	480i @60Hz, 4:2:2
	ITU-R BT.656	576i @50Hz, 4:2:2
Compatible Audio Format	3G-SDI	48kHz, 16 / 20 / 24-bit, 2 CH, Synchronized Video
	HD-SDI	48kHz, 16 / 20 / 24-bit, 2 CH, Synchronized Video
	SG-SDI	48kHz, 16 / 20 / 24-bit, 2 CH, Synchronized / Asynchronized Video
Max transmission distance 75-ohm coaxial cable	3G-SDI	150m at 2.97Gb/s
	HD-SDI	250m at 1.485Gb/s
	SG-SDI	480m at 270Mb/s

Table 5. 3G/HD/SD-SDI video formats

Appendix F – RackView Touchscreen

RackView LCD Panel with Touchscreen

The RackView KVM Drawer can be ordered with optional resistive touchscreen support.

The RackView Touchscreen option includes a 6ft (2.0m) USB cable and a CD including operating instructions.

RackView Resistive Touchscreen Option

Features	Resistive Touchscreen
Display Size	17" Widescreen
Technology	5-Wire Resistive
Touch Point	Single
Method	Stylus or Finger
Activation Force	≤ 50g / Stylus=R0.8
Durability	10 ~ 35 million touches
Response Time	15ms
Optical Transmittance	80% ± 3%
Surface Hardness	3H
Haze	8% ± 3%
Connector	USB Type A
Compatibility	Windows 7 / XP / Vista, Linux
Glass (17" DWS Widescreen)	Resistive: 17" DWS - 2.2 ±0.2 mm



Figure 14. Schematic showing the back panel with the touchscreen option (USB-A) installed

Please follow the below steps to setup the touch screen:-

Step 1. Run the bundled CD disc

Step 2. Double click the Setup.exe

Step 3. Follow the installation instruction to finish the setup

Step 4. After installation, run the TouchKit program & the "4 point calibration"

 Please do the initial calibration after the first setup

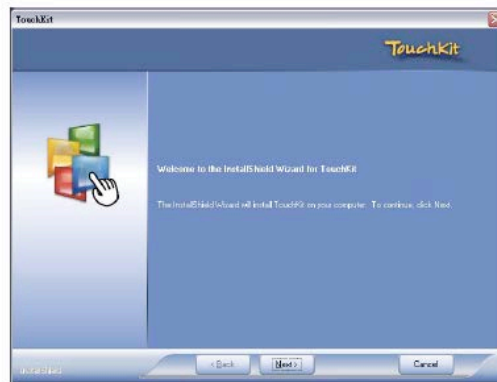

Figure 15. RackView touchscreen setup procedure

Appendix G – RackView DC Power Options

RackView DC Power

The RackView KVM Drawer can be ordered with optional DC power input as specified in the table below. Select the DC voltage required, then add the voltage to the RackView part number as /nnnDC. For example, adding 48VDC to a RackView 17" would result in **RV1-CAKVT17/DWS/HD/Kn/48DC** part number.

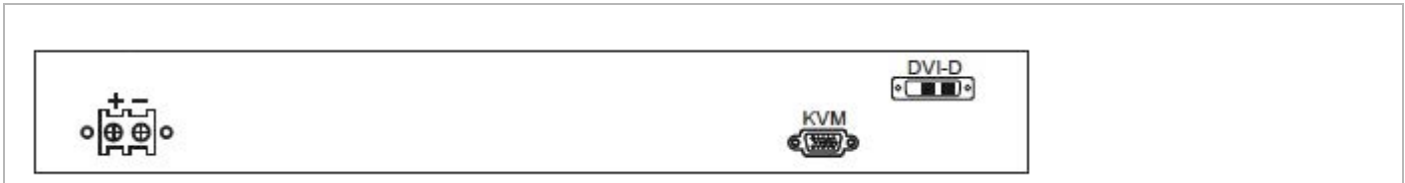

Figure 16. RackView with a DC power connector fitted

Model	12V	24V	48V	125V	250V
Input rating					
Input voltage:	12-Volt	24-Volt	48-Volt	110-Volt	300-Volt
Input range:	9 ~ 18V	18 ~ 36V	36 ~ 75V	66 ~ 160V	180 ~ 425V
Input current					
- No load	50 mA	50 mA	50 mA	35 mA	10 mA
- Full load	4950 mA	2450 mA	1220 mA	749 mA	600 mA
Output rating					
Output voltage:	12-Volt	12-Volt	12-Volt	12-Volt	12-Volt
Output current:	4.16A	4.16A	4.16A	6.25A	12.5A
Efficiency	84%	85%	85%	91%	86%

Table 6. RackView DC power options

The DC power option excludes the AC power adapter and power cord

ROSE.COM

WWW.ROSE.COM ▪ **sales@rose.com** ▪ **(800) 333-9343**

Rose Electronics ▪ 10707 Stancliff Road ▪ Houston, Texas 77099
Rose USA (281) 933-7673 ▪ Rose Europe +49 (0) 2454 969442
Rose Asia +65 6324 2322 ▪ Rose Australia +61 (0) 421 247083



WWW.ROSE.COM